

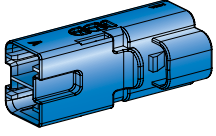









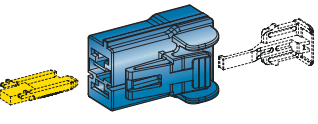

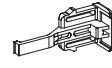
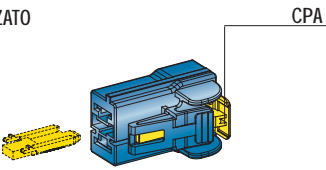

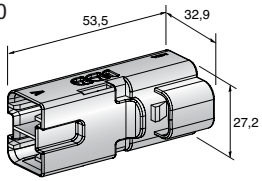

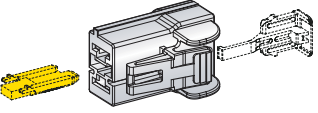

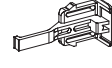
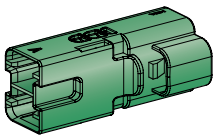
CONNECTOR

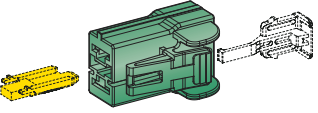
Connectors
Connecteurs
Steckgehäuse

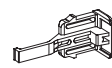
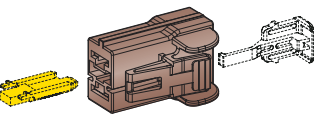
DISEGNO DRAWING DESSIN ZEICHNUNG	N. VIE N° WAYS N° VOIES N° POLIG	MATERIALE MATERIAL MATERIEL WERKSTOFF	TERMINALI TERMINALS COSSES KABELSCHUHE	SECONDARY LOCK CPA	FISSAGGI FIXINGS FIXAGES BEFESTIGUNG	REF.	PCS
	1	PA 66 GF25 Nero Black Noir Schwarz	M800	-		44.40200 45.40200	20 2400
	1	PA 66 GF25 Nero Black Noir Schwarz	F800	-	-	44.40100 45.40100	20 2400
POLARIZZATO 	1	PA 66 GF30 Blu Blue Bleu Blau	F800	-	-	45.40140	2400
POLARIZZATO 	1	PA 66 GF30 Grigio Grey Gris Grau	F800	-	-	45.40130	2400
CPA 	1	PA 66 GF30 Nero Black Noir Schwarz	F800	-	-	45.40150	350
	2	PA 66 GF25 Nero Black Noir Schwarz	M800	-		44.40400 45.40400	10 1200
	2	PA 66 GF30 Nero Black Noir Schwarz	F800	CPA 	-	44.40300 45.40300	10 1200
CPA 	2	PA 66 GF30 Nero Black Noir Schwarz	F800	-	-	45.40301	1200

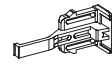
DISEGNO DRAWING DESSIN ZEICHNUNG	N. VIE N° WAYS N° VOIES N° POLIG	MATERIALE MATERIAL MATERIEL WERKSTOFF	TERMINALI TERMINALS COSSES KABELSCHUHE	SECONDARYLOCK CPA	FISSAGGI FIXINGS FIXAGES BEFESTIGUNG	REF.	PCS
POLARIZZATO 	2	PA 66 GF30 Blu Blue Bleu Blau	M800 	-		45.40410	1200
POLARIZZATO 	2	PA 66 GF30 Blu Blue Bleu Blau	F800 	CPA 	-	44.40310 45.40310	10 1200
POLARIZZATO 	2	PA 66 GF30 Blu Blue Bleu Blau	F800 	-	-	45.40311	1200
POLARIZZATO 	2	PA 66 GF30 Grigio Grey Gris Grau	M800 	-		45.40420	1200
POLARIZZATO 	2	PA 66 GF30 Grigio Grey Gris Grau	F800 	CPA 	-	44.40340 45.40340	10 1200
POLARIZZATO 	2	PA 66 GF30 Verde Green Vert Grün	M800 	-		45.40430	1200
POLARIZZATO 	2	PA 66 GF30 Verde Green Vert Grün	F800 	CPA 	-	45.40320	1200
POLARIZZATO 	2	PA 66 GF30 Marrone Brown Marron Braun	F800 	CPA 	-	45.40330	1200

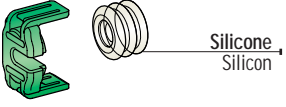
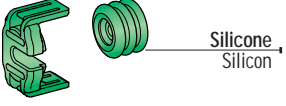
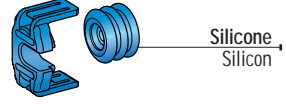
DISEGNO DRAWING DESSIN ZEICHNUNG	N. VIE N° WAYS N° VOIES N° POLIG	MATERIALE MATERIAL MATERIEL WERKSTOFF	TERMINALI TERMINALS COSSES KABELSCHUHE	SECONDARY LOCK CPA	FISSAGGI FIXINGS FIXAGES BEFESTIGUNG	REF.	PCS
<p>POLARIZZATO</p>	2	PA 66 GF13 Blu Blue Bleu Blau	F800 	CPA 	-	45.40500	600
<p>POLARIZZATO</p>	2	PA 66 GF13 Verde Green Vert Grün	F800 	CPA 	-	45.40501	600
	3	PA 66 GF25 Nero Black Noir Schwarz	M800 	-		44.40800 45.40800	10 1200
	3	PA 66 GF30 Nero Black Noir Schwarz	F800 	CPA 	-	44.40700 45.40700	10 1200
<p>POLARIZZATO</p>	3	PA 66 GF30 Blu Blue Bleu Blau	F800 	CPA 	-	45.40710	1200
<p>POLARIZZATO</p>	3	PA 66 GF30 Grigio Grey Gris Grau	F800 	CPA 	-	45.40730	1200
	2	PA 66 GF30 Nero Black Noir Schwarz	WP M800 	-		44.40901 45.40901	10 1000
	2	PA 66 GF30 Nero Black Noir Schwarz	F800 	-	-	44.40900 45.40900	10 1000

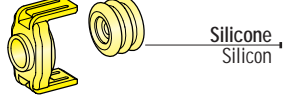
DISEGNO DRAWING DESSIN ZEICHNUNG	DESCRIZIONE DESCRIPTION DESCRIPTION BESCHREIBUNG	MATERIALE MATERIAL MATERIEL WERKSTOFF	REF.	PCS
	Tappo e tassello Plug and retainer Bouchon et fermeture Stopfen und Verschluss	PA 66 GF30 Verde Green Vert Grün	45.40950	1000
	Guarnizione e tassello per cavi Gasket and retainer for cables Garniture et fermeture pour câbles Dichtung und Verschluss für Kabeln 1,5÷2,5 mm ²	PA 66 GF30 Verde Green Vert Grün	45.40905	1000
	Guarnizione e tassello per cavi Gasket and retainer for cables Garniture et fermeture pour câbles Dichtung und Verschluss für Kabeln 4÷6 mm ²	PA 66 GF30 Blu Blue Bleu Blau	44.40906 45.40906	20 1000
	Guarnizione e tassello per cavi Gasket and retainer for cables Garniture et fermeture pour câbles Dichtung und Verschluss für Kabeln 8 mm ²	PA 66 GF30 Rosso Red Rouge Rot	44.40908 45.40908	20 1000
	Guarnizione e tassello per cavi Gasket and retainer for cables Garniture et fermeture pour câbles Dichtung und Verschluss für Kabeln 10 mm ²	PA 66 GF30 Giallo Yellow Jaune Gelb	44.40904 45.40904	20 1000

DISEGNO DRAWING DESSIN ZEICHNUNG	N. VIE N° WAYS N° VOIES N° POLIG	MATERIALE MATERIAL MATERIEL WERKSTOFF	TERMINALI TERMINALS COSSES KABELSCHUHE	SECONDARY LOCK CPA	FISSAGGI FIXINGS FIXAGES BEEFE-STIGUNG	REF.	PCS
	2	PA 66 GF30 Blu Blue Bleu Blau	WP M800 W/SEAL 	-		45.40210	600
	2	PA 66 GF30 Blu Blue Bleu Blau	WP F800 W/SEAL 	-	-	45.40110	600
	2	PA 66 GF30 Verde Green Vert Grün	WP F800 W/SEAL 	-	-	45.40111	600

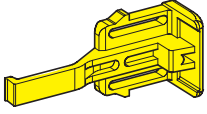
DISEGNO DRAWING DESSIN ZEICHNUNG	DESCRIZIONE DESCRIPTION DESCRIPTION BESCHREIBUNG	MATERIALE MATERIAL MATERIEL WERKSTOFF	REF.	PCS
	<p>CPA Connection Position Assurance</p>	<p>PA 66 GF30 Giallo Yellow Jaune Gelb</p>	<p>45.45300</p>	<p>2400</p>

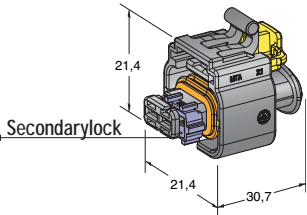
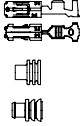
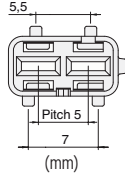
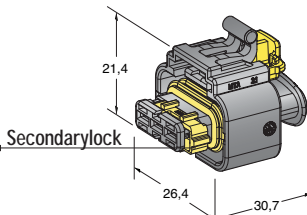
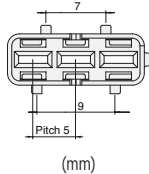
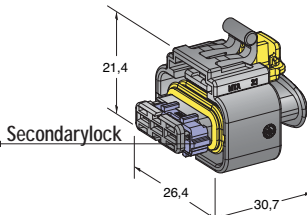
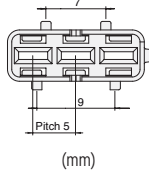
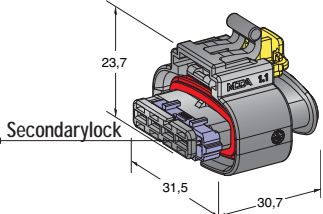
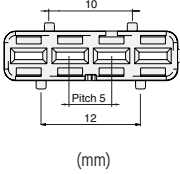
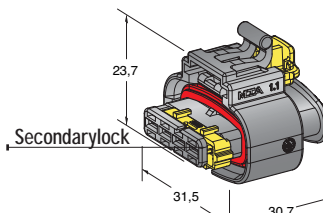
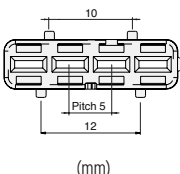
<p>DISEGNO DRAWING DESSIN ZEICHNUNG</p>	<p>N. VIE N° WAYS N° VOIES N° POLIG</p>	<p>MATERIALE MATERIAL MATÉRIEL WERKSTOFF</p>	<p>TERMINALI TERMINALS COSSES KABELSCHUHE</p>	<p>INGOMBRI DIMENSION DIMENSION MABE</p>	<p>REF.</p>	<p>PCS</p>
	<p>2</p>	<p>PA 66 GF30 Nero Black Noir Schwarz Guarnizione in Silicone Silicon Gasket Garniture en Silicon Silikon Dichtung</p>	<p>BDK BSK </p>		<p>45.10801</p>	<p>2500</p>
	<p>3</p>	<p>PA 66 GF30 Nero Black Noir Schwarz Guarnizione in Silicone Silicon Gasket Garniture en Silicon Silikon Dichtung</p>			<p>45.10810</p>	<p>2500</p>
	<p>3</p>	<p>PA 66 GF30 Nero Black Noir Schwarz Guarnizione in Silicone Silicon Gasket Garniture en Silicon Silikon Dichtung</p>			<p>45.10811</p>	<p>2500</p>
	<p>4</p>	<p>PA 66 GF30 Nero Black Noir Schwarz Guarnizione in Silicone Silicon Gasket Garniture en Silicon Silikon Dichtung</p>			<p>45.10821</p>	<p>2500</p>
	<p>4</p>	<p>PA 66 GF30 Nero Black Noir Schwarz Guarnizione in Silicone Silicon Gasket Garniture en Silicon Silikon Dichtung</p>			<p>45.10820</p>	<p>2500</p>

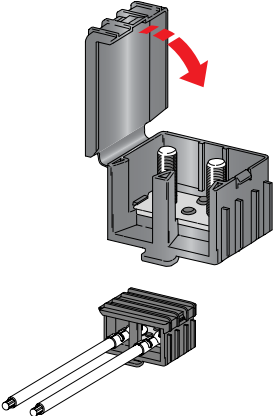
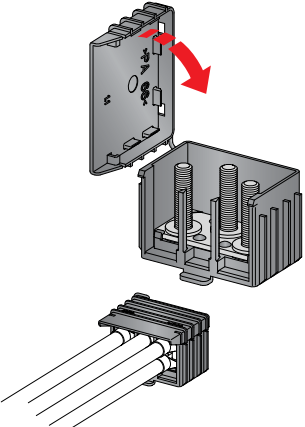
<p>DISEGNO DRAWING DESSIN ZEICHNUNG</p>	<p>N. VIE N° WAYS N° VOIES N° POLIG</p>	<p>DESCRIZIONE DESCRIPTION DESCRIPTION BESCHREIBUNG</p>	<p>MATERIALE MATERIAL MATERIEL WERKSTOFF</p>	<p>APPLICAZIONI APPLICATIONS APPLICATIONS ANWENDUNGEN</p>	<p>REF.</p>	<p>PCS</p>
	<p>2</p>	<p>Nodo di derivazione M88 Branch knot M88 Noeud de derivation M88 Verteiler M88</p>	<p>PA 66 Nero Black Noir Schwarz</p>	<p>-</p>	<p>44.41100 45.41100</p>	<p>1 100</p>
	<p>3</p>	<p>Nodo di derivazione M888 Branch knot M888 Noeud de derivation M888 Verteiler M888</p>	<p>PA 66 Nero Black Noir Schwarz</p>	<p>-</p>	<p>44.41200 45.41200</p>	<p>1 130</p>

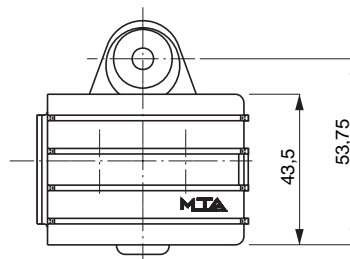
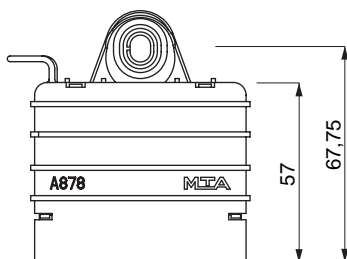
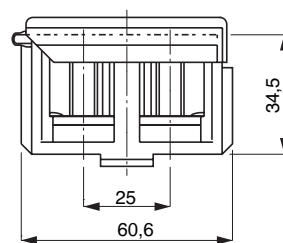
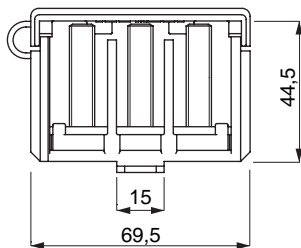

DISEGNO DRAWING DESSIN ZEICHNUNG	N. VIE N° WAYS N° VOIES N° POLIG	DESCRIZIONE DESCRIPTION DESCRIPTION BESCHREIBUNG	MATERIALE MATERIAL MATERIEL WERKSTOFF	APPLICAZIONI APPLICATIONS APPLICATIONS ANWENDUNGEN	REF.	PCS
	6	<p>A) Coperchio di protezione Protection cover Couvercle de protection Deckel</p> <p>B) Corpo con secondarylock e terminale 6 vie Housing with secondarylock and 6 way terminal Corps avec secondarylock et cosse 6 voies Verteiler mit secondarylock u. 6 polig Kabelschuhe</p>	<p>PA 66 Rosso Red Rouge Rot</p> <p>Corpo PA 66 GF25 Nero Black Noir Schwarz</p> <p>Terminale Cu ETP Nichelato</p> <p>Nero Black Noir Schwarz</p> <p>Secondarylock PA 66 GF25 Nero Black Noir Schwarz</p>		45.40602	200
<p>KIT</p>	6	KIT A+B	-		44.40600	1

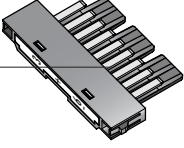
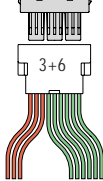
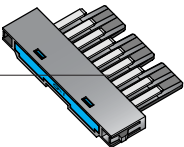
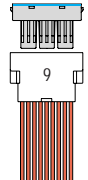
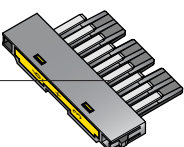
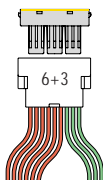
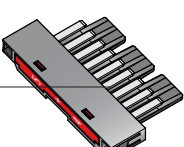
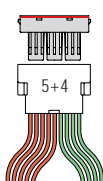
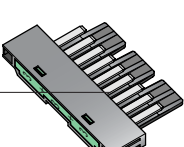
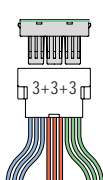
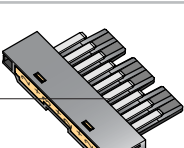
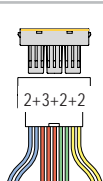
DISEGNO DRAWING DESSIN ZEICHNUNG	N. VIE N° WAYS N° VOIES N° POLIG	DESCRIZIONE DESCRIPTION DESCRIPTION BESCHREIBUNG	MATERIALE MATERIAL MATERIEL WERKSTOFF	TIPOLOGIE DI CONNESSIONE KINDS OF CONNECTIONS TIPOLOGIES DE CONNEXION VERBINDUNGEN TYPEN	REF.	PCS
 Terminals Cu	9	Porta terminali maschi For male terminals Pour coses males Für Flachstecker	PA 66 GF13 Nero Black Noir Schwarz	Coperchio PBT GF20 Bianco White Blanc Weiss		45.51609 2500
 Terminals Cu	9	Porta terminali maschi For male terminals Pour coses males Für Flachstecker	PA 66 GF13 Nero Black Noir Schwarz	Coperchio PBT GF20 Blu Blue Bleu Blau		44.10610 45.51610 10 2500
 Terminals Cu	9	Porta terminali maschi For male terminals Pour coses males Für Flachstecker	PA 66 GF13 Nero Black Noir Schwarz	Coperchio PBT GF20 Giallo Yellow Jaune Gelb		44.10611 45.51611 10 2500
 Terminals Cu	9	Porta terminali maschi For male terminals Pour coses males Für Flachstecker	PA 66 GF13 Nero Black Noir Schwarz	Coperchio PBT GF20 Rosso Red Rouge Rot		44.10612 45.51612 10 2500
 Terminals Cu	9	Porta terminali maschi For male terminals Pour coses males Für Flachstecker	PA 66 GF13 Nero Black Noir Schwarz	Coperchio PBT GF20 Verde Green Vert Grün		44.10613 45.51613 10 2500
 Terminals Cu	9	Porta terminali maschi For male terminals Pour coses males Für Flachstecker	PA 66 GF13 Nero Black Noir Schwarz	Coperchio PBT GF20 Beige Beige Beige Beige		44.10616 45.51616 10 2500

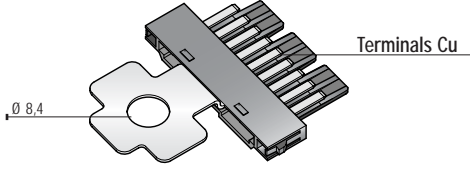
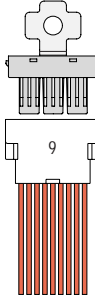
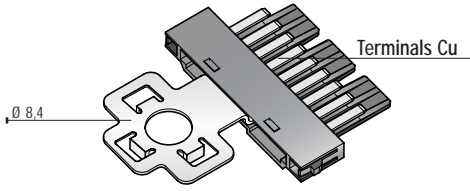
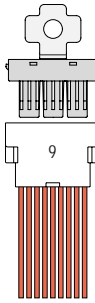
DISEGNO DRAWING DESSIN ZEICHNUNG	N. VIE N° WAYS N° VOIES N° POLIG	DESCRIZIONE DESCRIPTION DESCRIPTION BESCHREIBUNG	MATERIALE MATERIAL MATERIEL WERKSTOFF	TIPOLOGIE DI CONNESSIONE KINDS OF CONNECTIONS TIPOLOGIES DE CONNEXION VERBINDUNGEN TYPEN	REF.	PCS
	9	Porta terminali maschi di massa For earth male terminals Pour cosses males de masse Für masse Flachstecker	PA 66 GF13 Nero Black Noir Schwarz		44.10614 45.51614	10 2000
	9	TCK 12S Porta terminali maschi di massa For earth male terminals Pour cosses males de masse Für masse Flachstecker	PA 66 GF13 Nero Black Noir Schwarz		45.51615	2000

SCHEMA DI MONTAGGIO

Mounting example - Exemple de montage - Beispiel der Steckmöglichkeiten

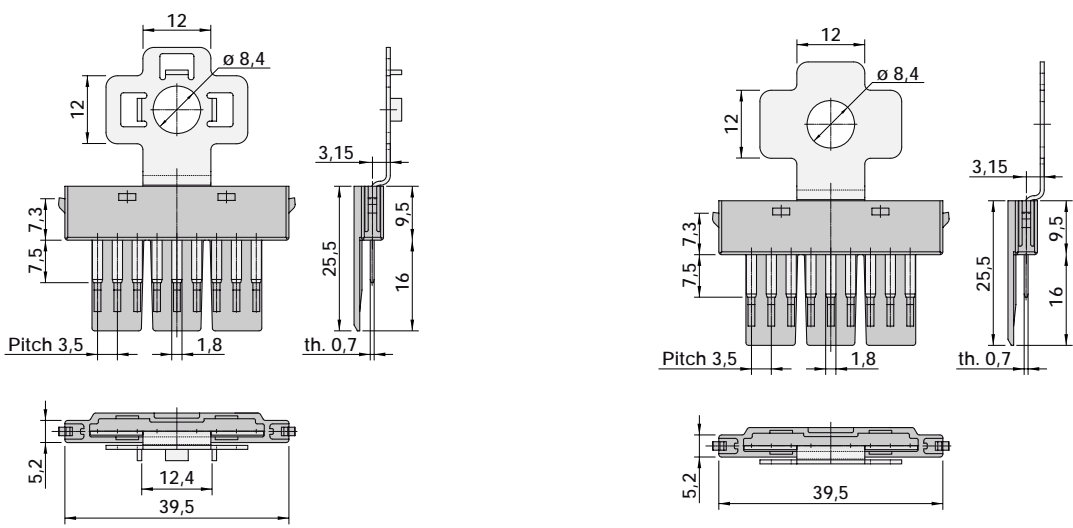

DISEGNO DRAWING DESSIN ZEICHNUNG	N. VIE N° WAYS N° VOIES N° POLIG	DESCRIZIONE DESCRIPTION DESCRIPTION BESCHREIBUNG	MATERIALE MATERIAL MATERIEL WERKSTOFF	TERMINALI TERMINALS COSSES KABELSCHUHE	REF.	PCS
	9	Porta terminale femmine Female holder Porte femelles Flachsteckhülsen	PBT Nero Black Noir Schwarz		44.10605 45.51605	10 2500
	9	Porta terminale femmine Female holder Porte femelles Flachsteckhülsen	PBT Blu Blue Bleu Blau		45.51606	2500
	9	Porta terminale femmine Female holder Porte femelles Flachsteckhülsen	PBT Verde Green Vert Grün		45.51607	2500
		Staffa di fissaggio Fixing plate Plaque de fixation Befestigungsplatte	PA 66 Nero Black Noir Schwarz		03.00397	2000

Fissaggio a pressione
 Pressure fixing
 Fixage a pression
 Durch Anpressung

SCHEMA DI MONTAGGIO

Mounting example - Exemple de montage - Beispiel der Steckmöglichkeiten

Quote per fissaggio laterale su lamiera (mm)
 Lateral fixing dimensions on plate (mm)
 Dimensions pour fixation laterale sur tôle (mm)
 Maße für Seitenbefestigung auf Blech (mm)

Max sp. 1,2 mm

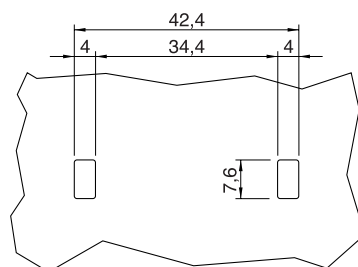
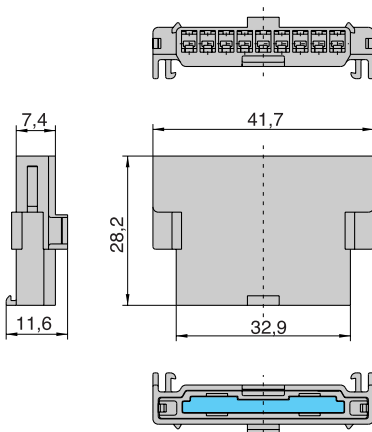

Esempio di aggancio
 Assembly example
 Exemple d'assemblage
 Beispiel der Steckmöglichkeiten

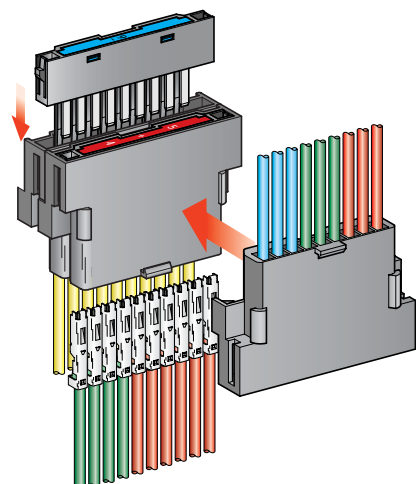

DISEGNO DRAWING DESSIN ZEICHNUNG	N. VIE N° WAYS N° VOIES N° POLIG	DESCRIZIONE DESCRIPTION DESCRIPTION BESCHREIBUNG	MATERIALE MATERIAL MATERIEL WERKSTOFF	TERMINALI TERMINALS COSSES KABELSCHUHE	REF.	PCS
	18	Porta terminale femmine Female holder Porte femelles Für Flachsteckhülsen	PA 66 GF30 Nero Black Noir Schwarz	JPT F280 070 NG F150 	44.10120 45.10120	1 1500
	18	Porta terminali maschi di massa For earth male terminals Pour cosse males de masse Für Masse Flachstecker	PA 66 GF30 Nero Black Noir Schwarz	-	44.10125 45.10125	1 1000
	18	TCK 12S Porta terminali maschi di massa For earth male terminals Pour cosse males de masse Für Masse Flachstecker	PA 66 GF30 Nero Black Noir Schwarz	-	45.10135	1000

SCHEMA DI MONTAGGIO

Mounting example - Exemple de montage - Beispiel der Steckmöglichkeiten

Porta terminali femmine
Female holder
Porte femelles
Flachsteckhülsen

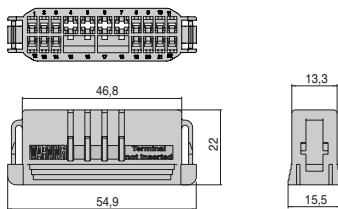

Esempio di aggancio
Assembly example
Exemple d'assemblage
Beispiel der Steckmöglichkeiten

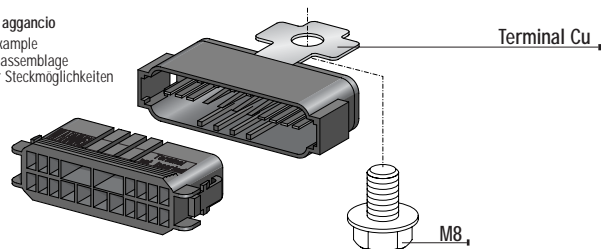

Porta terminali maschi di massa
For earth male terminals
Pour cosse males de masse
Für masse flachstecker

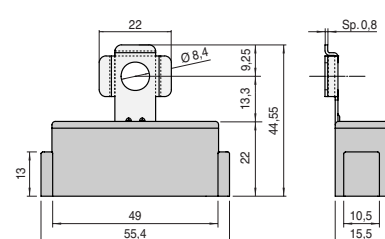
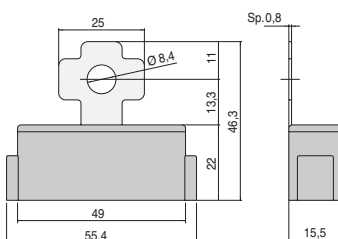

DISEGNO DRAWING DESSIN ZEICHNUNG	N. VIE N° WAYS N° VOIES N° POLIG	DESCRIZIONE DESCRIPTION DESCRIPTION BESCHREIBUNG	MATERIALE MATERIAL MATERIEL WERKSTOFF	TERMINALI TERMINALS COSSES KABELSCHUHE	REF.	PCS
	24	Porta terminale femmine WP Female holder WP Porte femelles WP Für Flachsteckhülsen Guarnizione Gasket Garniture Dichtung	Corpo PA 66 GF30 Nero Black Noir Schwarz Silicone Silicon	SICMA 2F280 CARALARM F150 	45.10110	600
	24	Porta terminale femmine Female holder Porte femelles Für Flachsteckhülsen	PA 66 GF30 Nero Black Noir Schwarz		45.10145	600
	24	Porta terminali maschi di massa For earth male terminals Pour cosse males de masse Für Masse Flachstecker	PA 66 GF30 Nero Black Noir Schwarz	-	45.10115	600
	24	TCK 12S Porta terminali maschi di massa For earth male terminals Pour cosse males de masse Für Masse Flachstecker	PA 66 GF30 Nero Black Noir Schwarz	-	45.10130	600

SCHEMA DI MONTAGGIO
Mounting example - Exemple de montage - Beispiel der Steckmöglichkeiten

Porta terminali femmine
Female holder
Porte femelles
Flachsteckhülsen

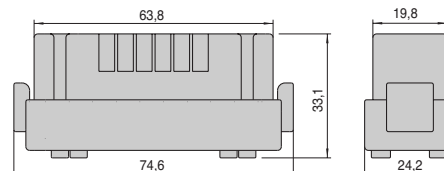
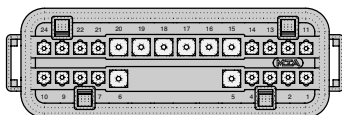



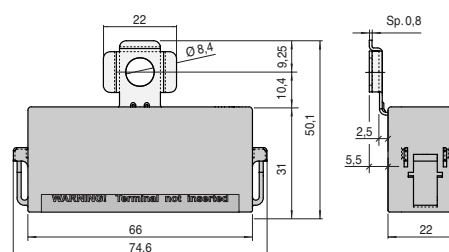
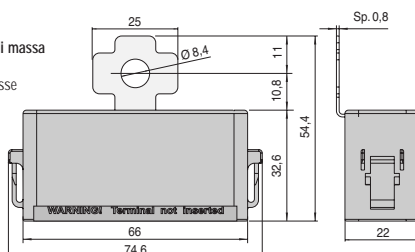



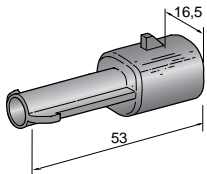
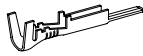
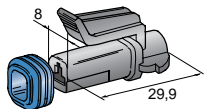

Porta terminali maschi di massa
For earth male terminals
Pour cosse males de masse
Für Masse Flachstecker

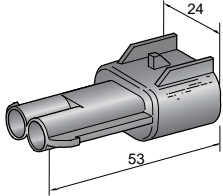
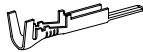
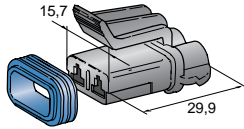

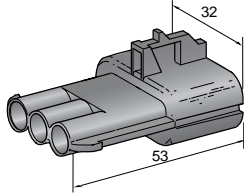
DISEGNO DRAWING DESSIN ZEICHNUNG	N. VIE N° WAYS N° VOIES N° POLIG	DESCRIZIONE DESCRIPTION DESCRIPTION BESCHREIBUNG	MATERIALE MATERIAL MATERIEL WERKSTOFF	TERMINALI TERMINALS COSSES KABELSCHUHE	REF.	PCS
	1	Connettore portamaschi Male holder connector Connecteur porte males Gehäuse für Flachstecker	PA 66 Nero Black Noir Schwarz	S-SEAL M150 	44.23610	10
		Kit A+B+C			30.50123	1
	1	Connettore portafemmine Female holder connector Connecteur porte femelles Gehäuse für Flachsteckhülsen	PA 66 Nero Black Noir Schwarz	S-SEAL F150 	44.23620	10
		Kit A+B+C			30.50124	1
	2	Connettore portamaschi Male holder connector Connecteur porte males Gehäuse für Flachstecker	PA 66 Nero Black Noir Schwarz	S-SEAL M150 	44.23630	10
		Kit A+B+C			30.50125	1
	2	Connettore portafemmine Female holder connector Connecteur porte femelles Gehäuse für Flachsteckhülsen	PA 66 Nero Black Noir Schwarz	S-SEAL F150 	44.23640	10
		Kit A+B+C			30.50126	1
	3	Connettore portamaschi Male holder connector Connecteur porte males Gehäuse für Flachstecker	PA 66 Nero Black Noir Schwarz	S-SEAL M150 	44.23650	10
		Kit A+B+C			30.50127	1
	3	Connettore portafemmine Female holder connector Connecteur porte femelles Gehäuse für Flachsteckhülsen	PA 66 Nero Black Noir Schwarz	S-SEAL F150 	44.23660	10
		Kit A+B+C			30.50128	1
	4	Connettore portamaschi Male holder connector Connecteur porte males Gehäuse für Flachstecker	PA 66 Nero Black Noir Schwarz	S-SEAL M150 	44.23670	5
		Kit A+B+C			30.50129	1
	4	Connettore portafemmine Female holder connector Connecteur porte femelles Gehäuse für Flachsteckhülsen	PA 66 Nero Black Noir Schwarz	S-SEAL F150 	44.23680	5
		Kit A+B+C			30.50130	1

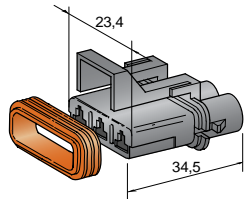
DISEGNO DRAWING DESSIN ZEICHNUNG	N. VIE N° WAYS N° VOIES N° POLIG	DESCRIZIONE DESCRIPTION DESCRIPTION BESCHREIBUNG	MATERIALE MATERIAL MATERIEL WERKSTOFF	TERMINALI TERMINALS COSSES KABELSCHUHE	REF.	PCS
	5	Connettore portamaschi Male holder connector Connecteur porte males Gehäuse für Flachstecker	PA 66 Nero Black Noir Schwarz	S-SEAL M150 	44.23690	5
		Kit A+B+C			30.50131	1
	5	Connettore portafemmine Female holder connector Connecteur porte femelles Gehäuse für Flachsteckhülsen	PA 66 Nero Black Noir Schwarz	S-SEAL F150 	44.23700	5
		Kit A+B+C			30.50132	1
	6	Connettore portamaschi Male holder connector Connecteur porte males Gehäuse für Flachstecker	PA 66 Nero Black Noir Schwarz	S-SEAL M150 	44.23710	5
		Kit A+B+C			30.50133	1
	6	Connettore portafemmine Female holder connector Connecteur porte femelles Gehäuse für Flachsteckhülsen	PA 66 Nero Black Noir Schwarz	S-SEAL F150 	44.23720	5
		Kit A+B+C			30.50134	1
	3	Tappo diagnostica	PA 66 Nero Black Noir Schwarz	44.23660 	44.23355	5

DISEGNO DRAWING DESSIN ZEICHNUNG	N. VIE N° WAYS N° VOIES N° POLIG	DESCRIZIONE DESCRIPTION DESCRIPTION BESCHREIBUNG	MATERIALE MATERIEL WERKSTOFF	TERMINALI TERMINALS COSSES KABELSCHUHE	REF.	PCS
	1	Connettore portamaschi Male holder connector Connecteur porte males Gehäuse für Flachstecker	PA 66 Nero Black Noir Schwarz	METRIPACK M280 	44.23520	5
	1	Connettore portafemmine Female holder connector Connecteur porte femelles Gehäuse für Flachsteckhülsen	PA 66 Nero Black Noir Schwarz	METRIPACK F280 	44.23510	5
	2	Connettore portamaschi Male holder connector Connecteur porte males Gehäuse für Flachstecker	PA 66 Nero Black Noir Schwarz	METRIPACK M280 	44.23540	5
	2	Connettore portafemmine Female holder connector Connecteur porte femelles Gehäuse für Flachsteckhülsen	PA 66 Nero Black Noir Schwarz	METRIPACK F280 	44.23530	5
	3	Connettore portamaschi Male holder connector Connecteur porte males Gehäuse für Flachstecker	PA 66 Nero Black Noir Schwarz	METRIPACK M280 	44.23560	5
	3	Connettore portafemmine Female holder connector Connecteur porte femelles Gehäuse für Flachsteckhülsen	PA 66 Nero Black Noir Schwarz	METRIPACK F280 	44.23550	5

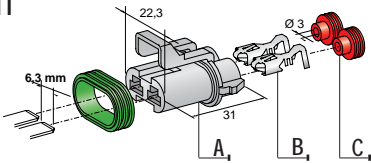



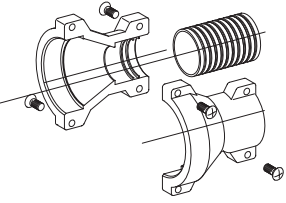

DISEGNO DRAWING DESSIN ZEICHNUNG	N. VIE N° WAYS N° VOIES N° POLIG	DESCRIZIONE DESCRIPTION DESCRIPTION BESCHREIBUNG	MATERIALE MATERIAL MATERIEL WERKSTOFF	SEZIONE CAVO CABLE SECTION SECTION DU CABLE KABEL QUERSCHNITT mm ²	SPESSORE THICKNESS EPAISSEUR STÄRKE mm	REF.	PCS
KIT 	2	KIT A+B+C	A) PA 66 Grigio Grey Gris Grau B) CuSn - Sn C) Silicon	1.0÷2.0	0.35	44.33800	1

DISEGNO DRAWING DESSIN ZEICHNUNG	N. VIE N° WAYS N° VOIES N° POLIG	DESCRIZIONE DESCRIPTION DESCRIPTION BESCHREIBUNG	MATERIALE MATERIAL MATERIEL WERKSTOFF	TERMINALI E GOMMINI TERMINALS AND RUBBER CÔSSES ET BOUCHON KABELSCHUHE GUMMIDICHTUNG	COLORE COLOUR COULEUR FARBE	REF.	PCS
	2	Connettore Connector Connecteur Steckgehäuse	PA	JT M280 	Nero Black Noir Schwarz	44.10660	10
<p>Con molletta di ritegno.</p>	2	A) Connettore Connector Connecteur Steckgehäuse	PA	JT F280 	Nero Black Noir Schwarz	44.20900 45.20900	10 500
		B) Cappuccio Cover Capuchon Gummikappe	Gomma Rubber Caoutchouc Gummi			44.20901 45.20901	10 500
		C) Cappuccio Cover Capuchon Gummikappe	Gomma Rubber Caoutchouc Gummi			44.20902 45.20902	10 500
	2	Connettore Connector Connecteur Steckgehäuse	PA	JPT WP F280 	Nero Black Noir Schwarz	44.10661	10
<p>Con molletta di ritegno.</p>	2	A) Connettore Connector Connecteur Steckgehäuse	PA	JPT WP F280 	Nero Black Noir Schwarz	44.20910 45.20910	10 500
					Grigio Grey Gris Grau	44.10651	10
					Giallo Yellow Jaune Gelb	44.10652	10
					Blu Blue Bleu Blau	44.10653	10
		B) Cappuccio Cover Capuchon Gummikappe	Gomma Rubber Caoutchouc Gummi		Nero Black Noir Schwarz	44.20911 45.20911	10 500

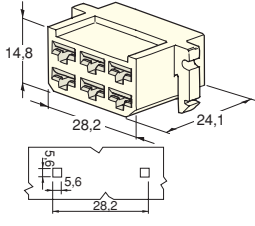
DISEGNO DRAWING DESSIN ZEICHNUNG	N. VIE N° WAYS N° VOIES N° POLIG	DESCRIZIONE DESCRIPTION DESCRIPTION BESCHREIBUNG	MATERIALE MATERIAL MATERIEL WERKSTOFF	TERMINALI E GOMMINI TERMINALS AND RUBBER CÔSSES ET BOUCHON KABELSCHUHE GUMMIDICHTUNG	COLORE COLOUR COULEUR FARBE	REF.	PCS
<p>Con molletta di ritegno,</p>	3	A) Connettore Connector Connecteur Steckgehäuse	PA	JPT WP F280 	Nero Black Noir Schwarz	44.20920	10
		B) Cappuccio Cover Capuchon Gummikappe	Gomma Rubber Caoutchouc Gummi			44.20921 45.20921	10 500
<p>Con molletta di ritegno,</p>	4	Connettore Connector Connecteur Steckgehäuse	PA	JPT WP F280 	Nero Black Noir Schwarz	44.10655	10
<p>Con molletta di ritegno,</p>	5	Connettore Connector Connecteur Steckgehäuse	PA	JPT WP F280 	Nero Black Noir Schwarz	44.10656	10
<p>Con molletta di ritegno,</p>	6	Connettore Connector Connecteur Steckgehäuse	PA	JPT WP F280 	Nero Black Noir Schwarz	44.10657	10
<p>Con molletta di ritegno,</p>	7	Cappuccio Cover Capuchon Gummikappe	Gomma Rubber Caoutchouc Gummi	JT F280 	Nero Black Noir Schwarz	44.20931 45.20931	5 500

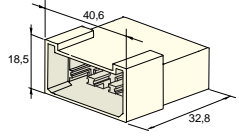
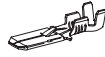
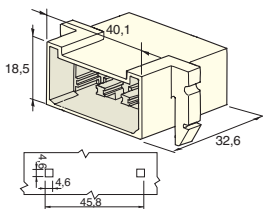
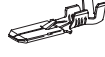
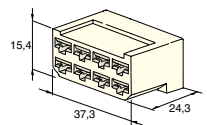

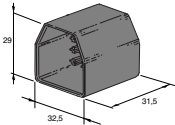
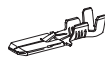
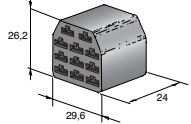



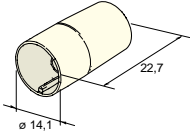
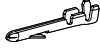
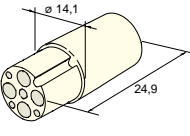
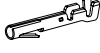

DISEGNO DRAWING DESSIN ZEICHNUNG	N. VIE N° WAYS N° VOIES N° POLIG	DESCRIZIONE DESCRIPTION DESCRIPTION BESCHREIBUNG	MATERIALE MATERIAL MATERIEL WERKSTOFF	TERMINALI E GOMMINI TERMINALS AND RUBBER CÔSSES ET BOUCHON KABELSCHUHE GUMMIDICHTUNG	COLORE COLOUR COULEUR FARBE	REF.	PCS
	3	Adattatore per connettori Adapter for connectors Adaptateur pour connecteurs Adapter für Steckgehäuse	PA 66 Viti/Screws Steel Ci 4,8 Zinc Plated	-	Nero Black Noir Schwarz	45.51575	500

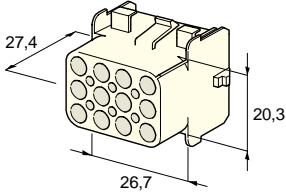
DISEGNO DRAWING DESSIN ZEICHNUNG	N. VIE N° WAYS N° VOIES N° POLIG	DESCRIZIONE DESCRIPTION DESCRIPTION BESCHREIBUNG	MATERIALE MATERIAL MATERIEL WERKSTOFF	TERMINALI TERMINALS COSSES KABELSCHUHE	REF.	PCS
	1	Connettore portamaschi Male holder connector Connecteur porte males Gehäuse für Flachstecker	PA Neutro Neutral Neutre Natur	 FASTON M630 C/DENTE	44.10150 45.10150	100 2500
	1	Connettore portafemmine Female holder connector Connecteur porte femelles Gehäuse für Flachsteckhülsen	PA Neutro Neutral Neutre Natur	 FASTON F630 C/DENTE	44.10160 45.10160	100 2500
	2	Connettore portamaschi Male holder connector Connecteur porte males Gehäuse für Flachstecker	PA Neutro Neutral Neutre Natur	 FASTON M630 C/DENTE	44.10170 45.10170	50 2500
	2	Connettore portafemmine Female holder connector Connecteur porte femelles Gehäuse für Flachsteckhülsen	PA Neutro Neutral Neutre Natur	 FASTON F630 C/DENTE	44.10180 45.10180	50 2500
	2	Connettore portamaschi Male holder connector Connecteur porte males Gehäuse für Flachstecker	PA Neutro Neutral Neutre Natur	 FASTON M630 C/DENTE	44.10190 45.10190	50 2500
	2	Connettore portafemmine Female holder connector Connecteur porte femelles Gehäuse für Flachsteckhülsen	PA Neutro Neutral Neutre Natur	 FASTON F630 C/DENTE	44.10200 45.10200	50 2500
	3	Connettore portamaschi Male holder connector Connecteur porte males Gehäuse für Flachstecker	PA Neutro Neutral Neutre Natur	 FASTON M630 C/DENTE	44.10210 45.10210	50 2500
	3	Connettore portafemmine Female holder connector Connecteur porte femelles Gehäuse für Flachsteckhülsen	PA Neutro Neutral Neutre Natur	 FASTON F630 C/DENTE	44.10220 45.10220	50 2500
	3	Connettore portafemmine Female holder connector Connecteur porte femelles Gehäuse für Flachstecker	PP Nero Black Noir Schwarz	 FASTON F630 C/DENTE	44.10140 45.10140	100 1000
	4	Connettore portamaschi Male holder connector Connecteur porte males Gehäuse für Flachstecker	PA Neutro Neutral Neutre Natur	 FASTON M630 C/DENTE	44.10230 45.10230	25 2500
	4	Connettore portafemmine Female holder connector Connecteur porte femelles Gehäuse für Flachsteckhülsen	PA Neutro Neutral Neutre Natur	 FASTON F630 C/DENTE	44.10240 45.10240	25 2500
	6	Connettore portamaschi Male holder connector Connecteur porte males Gehäuse für Flachstecker	PA Neutro Neutral Neutre Natur	 FASTON M630 C/DENTE	44.10250 45.10250	25 1000

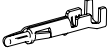
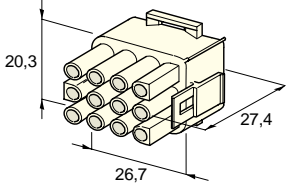

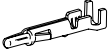
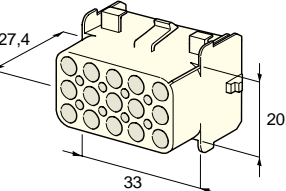

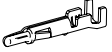
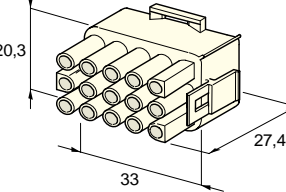

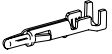



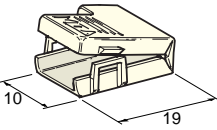

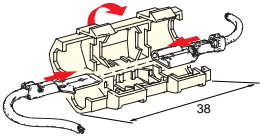

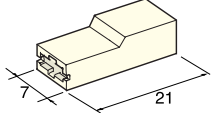
DISEGNO DRAWING DESSIN ZEICHNUNG	N. VIE N° WAYS N° VOIES N° POLIG	DESCRIZIONE DESCRIPTION DESCRIPTION BESCHREIBUNG	MATERIALE MATERIAL MATERIEL WERKSTOFF	TERMINALI TERMINALS COSSES KABELSCHUHE	REF.	PCS
	6	Connettore portafemmine Female holder connector Connecteur porte femelles Gehäuse für Flachsteckhülsen	PA Neutro Neutral Neutre Natur	FASTON F630 C/DENTE 	44.10260 45.10260	25 1000
	8	Connettore portamaschi Male holder connector Connecteur porte males Gehäuse für Flachstecker	PA Neutro Neutral Neutre Natur	FASTON M630 C/DENTE 	44.10270 45.10270	20 1000
	8	Connettore portamaschi Male holder connector Connecteur porte males Gehäuse für Flachstecker	PA Neutro Neutral Neutre Natur	FASTON M630 C/DENTE 	44.10290 45.10290	10 1000
	8	Connettore portafemmine Female holder connector Connecteur porte femelles Gehäuse für Flachsteckhülsen	PA Neutro Neutral Neutre Natur	FASTON F630 C/DENTE 	44.10280 45.10280	20 1000
	11	Connettore portamaschi Male holder connector Connecteur porte males Gehäuse für Flachstecker	PA Nero Black Noir Schwarz	FASTON M630 C/DENTE 	44.10295 45.10295	20 150
	11	Connettore portafemmine Female holder connector Connecteur porte femelles Gehäuse für Flachsteckhülsen	PA Nero Black Noir Schwarz	FASTON F630 C/DENTE 	44.10296 45.10296	20 250

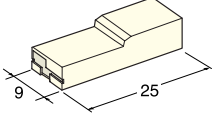
DISEGNO DRAWING DESSIN ZEICHNUNG	N. VIE N° WAYS N° VOIES N° POLIG	DESCRIZIONE DESCRIPTION DESCRIPTION BESCHREIBUNG	MATERIALE MATERIAL MATERIEL WERKSTOFF	TERMINALI TERMINALS COSSES KABELSCHUHE	REF.	PCS
	4	Connettore portamaschi Male holder connector Connecteur porte males Gehäuse für Flachstecker	PA Neutro Neutral Neutre Natur	L20 M2,1 	44.10790	10
	4	Connettore portafemmine Female holder connector Connecteur porte femelles Gehäuse für Flachsteckhülsen	PA Neutro Neutral Neutre Natur	L20 F2 	44.10791	10

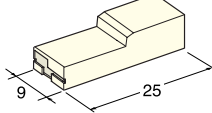
DISEGNO DRAWING DESSIN ZEICHNUNG	N. VIE N° WAYS N° VOIES N° POLIG	DESCRIZIONE DESCRIPTION DESCRIPTION BESCHREIBUNG	MATERIALE MATERIAL MATERIEL WERKSTOFF	TERMINALI TERMINALS COSSES KABELSCHUHE	REF.	PCS
	2	Connettore portamaschi/femmine Male/female holder connector Connecteur porte males/femmes Gehäuse für Flachstecker/hülsen	PA Neutro Neutral Neutre Natur	MATE-N-LOCK F2 MATE-N-LOCK M2 	44.26040	10
	2	Connettore portamaschi/femmine Male/female holder connector Connecteur porte males/femmes Gehäuse für Flachstecker/hülsen	PA Neutro Neutral Neutre Natur	MATE-N-LOCK F2 MATE-N-LOCK M2 	44.26030	10
	3	Connettore portamaschi/femmine Male/female holder connector Connecteur porte males/femmes Gehäuse für Flachstecker/hülsen	PA Neutro Neutral Neutre Natur	MATE-N-LOCK F2 MATE-N-LOCK M2 	44.26060	10
	3	Connettore portamaschi/femmine Male/female holder connector Connecteur porte males/femmes Gehäuse für Flachstecker/hülsen	PA Neutro Neutral Neutre Natur	MATE-N-LOCK F2 MATE-N-LOCK M2 	44.26050	10
	6	Connettore portamaschi/femmine Male/female holder connector Connecteur porte males/femmes Gehäuse für Flachstecker/hülsen	PA Neutro Neutral Neutre Natur	MATE-N-LOCK F2 MATE-N-LOCK M2 	44.26120	10
	6	Connettore portamaschi/femmine Male/female holder connector Connecteur porte males/femmes Gehäuse für Flachstecker/hülsen	PA Neutro Neutral Neutre Natur	MATE-N-LOCK F2 MATE-N-LOCK M2 	44.26110	10
	9	Connettore portamaschi/femmine Male/female holder connector Connecteur porte males/femmes Gehäuse für Flachstecker/hülsen	PA Neutro Neutral Neutre Natur	MATE-N-LOCK F2 MATE-N-LOCK M2 	44.26140	10
	9	Connettore portamaschi/femmine Male/female holder connector Connecteur porte males/femmes Gehäuse für Flachstecker/hülsen	PA Neutro Neutral Neutre Natur	MATE-N-LOCK F2 MATE-N-LOCK M2 	44.26130	10

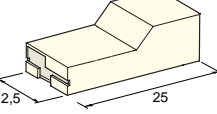
DISEGNO DRAWING DESSIN ZEICHNUNG	N. VIE N° WAYS N° VOIES N° POLIG	DESCRIZIONE DESCRIPTION DESCRIPTION BESCHREIBUNG	MATERIALE MATERIAL MATERIEL WERKSTOFF	TERMINALI TERMINALS COSSES KABELSCHUHE	REF.	PCS
	12	Connettore portamaschi/femmine Male/female holder connector Connecteur porte males/femmes Gehäuse für Flachstecker/hülsen	PA Neutro Neutral Neutre Natur	MATE-N-LOCK F2  MATE-N-LOCK M2 	44.26160	10
	12	Connettore portamaschi/femmine Male/female holder connector Connecteur porte males/femmes Gehäuse für Flachstecker/hülsen	PA Neutro Neutral Neutre Natur	MATE-N-LOCK F2  MATE-N-LOCK M2 	44.26150	10
	15	Connettore portamaschi/femmine Male/female holder connector Connecteur porte males/femmes Gehäuse für Flachstecker/hülsen	PA Neutro Neutral Neutre Natur	MATE-N-LOCK F2  MATE-N-LOCK M2 	44.26180	10
	15	Connettore portamaschi/femmine Male/female holder connector Connecteur porte males/femmes Gehäuse für Flachstecker/hülsen	PA Neutro Neutral Neutre Natur	MATE-N-LOCK F2  MATE-N-LOCK M2 	44.26170	10

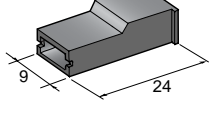
DISEGNO DRAWING DESSIN ZEICHNUNG	MATERIALE MATERIAL MATERIEL WERKSTOFF	TERMINALI INSERIBILI TERMINALS TO INSERT COSSES INSERABLES KABELSCHUHE	REF.	PCS
	PE Nero Black Noir Schwarz	FASTON F630 13.01400 	44.10070 45.10070	200 20000
	PE Giallo Yellow Jaune Gelb	FASTON F630 13.01400 	44.10072 45.10072	200 20000
	PE Blu Blue Bleu Blau	FASTON F630 13.01400 	44.10073 45.10073	200 20000
	PE Rosso Red Rouge Rot	FASTON F630 13.01400 	44.10074 45.10074	200 20000
	PE Neutro Neutral Neutre Natur	FASTON F630 13.01400 	44.10076 45.10076	200 20000
	PE Nero Black Noir Schwarz	FASTON M630 13.01412 	44.10080 45.10080	200 20000
	PE Blu Blue Bleu Blau	FASTON M630 13.01412 	44.10081 45.10081	200 20000
	PE Giallo Yellow Jaune Gelb	FASTON M630 13.01412 	44.10082	200
	PE Rosso Red Rouge Rot	FASTON M630 13.01412 	44.10084 45.10084	200 20000
	PE Neutro Neutral Neutre Natur	FASTON M630 13.01412 	44.10086 45.10086	200 20000
	PE Neutro Neutral Neutre Natur	FASTON F280 13.01390 	44.10065	200
	PE Neutro Neutral Neutre Natur	FASTON F480 13.01391 	44.10068	200

DISEGNO DRAWING DESSIN ZEICHNUNG	MATERIALE MATERIAL MATERIEL WERKSTOFF	TERMINALI INSERIBILI TERMINALS TO INSERT COSSES INSERABLES KABELSCHUHE	REF.	PCS
	PA Neutro Neutral Neutre Natur	FASTON F630 FLAG 	44.10060 45.10060	200 10000
	PA Neutro Neutral Neutre Natur	FASTON F630 - FASTON M630 	44.10083	50
	PA Neutro Neutral Neutre Natur	FASTON F480 13.01391 	44.10062	200
	PA Neutro Neutral Neutre Natur	FASTON F630 13.01400 	44.10077 45.10077	200 20000
	PA Neutro Neutral Neutre Natur	FASTON F630 	44.10078	200
	PA Neutro Neutral Neutre Natur	FASTON F950 13.01420 	44.10079	50
	PA Nero Black Noir Schwarz	ANTISF F630 11.07000 - 11.07010 	44.20800 45.20800	50 20000

DISEGNO DRAWING DESSIN ZEICHNUNG	N. VIE N° WAYS N° VOIES N° POLIG	VOLT	In	MATERIALE MATERIAL MATERIEL WERKSTOFF	TEMPERATURA D'ESERCIZIO OPERATION TEMPERATURE TEMPERATURE D'EXERCISE BETRIEB TEMPERATUR	SEZIONE CAVO CABLE SECTION SECTION DU CÂBLE KABEL QUERSCHNITT mm ²	REF.	
	12	380	24A	PP Nero Black Noir Schwarz	85 °C	2.5	44.30100	10
	12	380	24A	PP Nero Black Noir Schwarz	85 °C	6	44.30110	10
	12	450	24A	PP Nero Black Noir Schwarz	85 °C	10	44.30120	10
	12	450	24A	PP Nero Black Noir Schwarz	85 °C	16	44.30130	10